

Pålastning i transportör  
med hjälp av gavlarna

Buffertrem för  
provtagningsutrustning



Matningsband inom bryggeri-  
och kosmetikindustrin

### Kuggremmen

Breco- och Brecoflexkuggremmen kännetecknas av hög kvalitet tack vare en slitstarkt polyuretanplast och en töjningsstabil stålkord. Genom att belägga kuggsidan med polyamid får remmen goda glidegenskaper i de fall glidskenor används. Brecoflex-kuggremmen levereras i obegränsade längder i en multipel av vald kuggdelning.

### Medbringaren

Medbringaren består av samma typ av högvärdig polyuretanplast som själva kuggremmen. Standardtyper återfinns på sidorna 98–105.

Även medbringare i specialutförande finns att få. Dessa tillverkas efter kundens önskemål och inom ramen för våra tillverkningsmöjligheter.

### Medbringarkuggremmen

En kuggrem kan förses med påsvetsade medbringare i godtyckligt antal och godtycklig delning, anpassade för önskad transportuppgift. Hänsyn måste dock tas till de riktlinjer som beskrivs på följande sidor.

Kuggremmarna och medbringarna tillverkas hos Breco Antriebstechnik GmbH som även utför fastsvetsningen av medbringarna efter kundens önskemål.



Kuggremmar med medbringare

<b>Tillvägagångssätt</b>	Den omgivande konstruktionen avgör valet av kuggremtyp, remlängd och kuggremhjul. Samtliga kuggremmar i vårt program kan förses med medbringare. Tillsammans med glidskenor uppnås dessutom en smidig transportördrift. Som alternativ kan kuggremmar i PAZ-utförande väljas (PAZ = polyamidbeläggning på kuggsidan, se sidan 87).
<b>Val av medbringare</b>	Vilken typ av medbringare som väljs avgörs av vilken typ av gods som skall transporteras och hur transporten skall ske. Följande medbringarutföranden finns:
<b>Standard</b>	Medbringarna extruderas i PUR. Från och med sidan 100 finns måttskisser för medbringare i standardutförande. Standardmedbringare kan efterbearbetas enligt kundritning genom fräsning eller borrarning.
<b>Semi-standard</b>	Medbringare tillverkas i erforderligt antal av förtillverkade PUR-plattor. Följande plattjocklekar finns som standard: 1,5; 2; 3; 4; 5; 6; 8; 10; 11; 15 och 20 mm
<b>Specialutförande</b>	Om kunden önskar kan vi inom ramen för vår tillverkning framställa formsprutade medbringare i olika former utan egentliga inskränkningar. Endast en del av verktygskostnaden tillkommer.
<b>Material</b>	PUR (ca 92 Shore A), samma material som i kuggremmarna.

**Svetsfogens  
läge I förhållande  
till kuggen**



Kuggremmens böjlighet ligger i huvudsak i kuggluckan. För att remmen även skall vara böjlig runt kuggremhjulet, skall medbringaren placeras mitt över en kugg som bilden visar.

### Medbringardelning

Medbringardelningen bör väljas som en jämn multipel av kuggdelningen. Medbringardelning, som inte är en jämn multipel är möjlig, men då måste man tänka på att delningen är jämnt delbar med remlängden, samt iaktta rekommendationer för minsta kuggantal för kuggremhjul. (Se nästa sida)

### Beställningsexempel

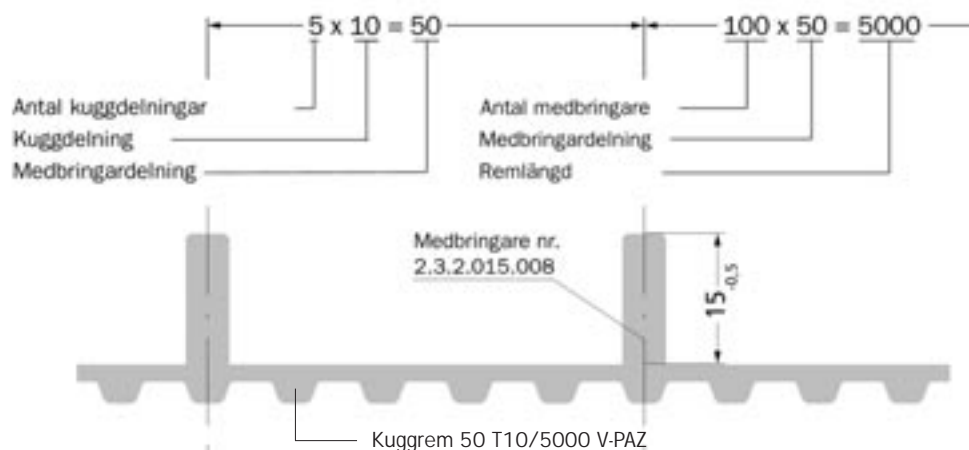

Medbringarna monteras som en jämn multipel av kuggdelningen, dvs. medbringarnas position följer exakt remsens kuggdelning. Något summeringsfel från medbringardelning till kuggdelning uppstår inte.

### Toleranser

Medbringarna svetsas fast med en noggrannhet av  $\pm 0,5$  mm i relation till det önskade värdet. För medbringarhöjden gäller toleransen  $- 0,5$  mm.

### Artikelnummer Beställningstext

Vid beställning av en kuggrem med medbringare bör en ritning med erforderliga mått och data bifogas. Medbringarkuggremmen kan också beställas genom att till exempel följande text anges: Breco kuggrem 50 T 10/5000 V-PAZ med 100 st påsvetsade medbringare, nr 2.3.2.015.008, medbringardelning 50, medbringarna svetsas ovanför remkuggarna.

### Svetsvulst



Vid fastsvetsningen av medbringaren lämnar svetsen en vulst med radien 0,5 - 1 mm.

Om vulsten påverkar medbringarens funktion, beställ med tillägget "svetsvulst bortfräst".

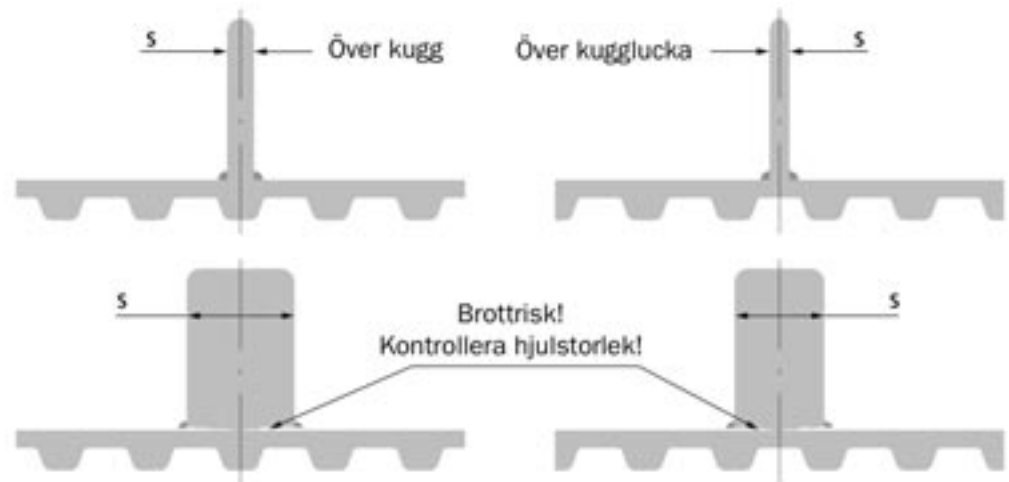

Kuggremmens flexibilitet påverkas av påsvetsade medbringare. Som regel bör medbringarna vara så smala som möjligt och placeras över en kugg för att erhålla bästa möjliga flexibilitet i kuggremmen. I nedanstående tabell anges rekommenderad maxtjocklek i mm i förhållande till valt antal kuggar i kuggremshjulet.

Max medbringartjocklek s i mm	Antal kuggar på kuggremshjulet						
	20	25	30	40	50	60	100
T 5	5 (2)	6 (2)	6 (3)	8 (4)	9 (6)	10 (8)	12 (10)
T 10	8 (3)	9 (4)	10 (4)	12 (6)	14 (9)	15 (12)	20 (20)
T 20	12 (5)	13 (5)	15 (6)	18 (8)	20 (12)	23 (20)	30 (30)
AT 5	5 (2)	6 (2)	6 (3)	8 (4)	9 (6)	10 (8)	12 (10)
AT 10*	8 (3)	9 (4)	10 (4)	12 (6)	14 (9)	15 (12)	20 (20)
AT 20	12 (5)	13 (5)	15 (6)	18 (6)	20 (12)	23 (20)	30 (30)
XL	5 (2)	6 (2)	6 (3)	8 (4)	9 (6)	10 (8)	12 (10)
L	6 (3)	7 (3)	8 (4)	10 (5)	12 (7)	13 (10)	16 (16)
H	8 (4)	9 (5)	10 (6)	12 (7)	14 (10)	15 (12)	20 (20)
XH	13 (5)	14 (5)	15 (6)	18 (8)	20 (12)	23 (20)	30 (30)

\* kan även användas för BAT- och SFAT-kuggremmar

Exempel på bestämning av medbringartjockleken hos en Breco-kuggrem med delning T10 som löper runt ett kuggremshjul med 20 kuggar:

- För medbringarposition "över kugg", tjocklek  $s \leq 8$  mm
- För medbringarposition "över kugglucka", tjocklek  $s \leq 3$  mm

Observera: vid kuggantal som ligger mellan i tabellen angivna värden, t.ex. 22 kuggar, bör närmast lägre värde väljas för max medbringartjocklek.

## Medbringare med frigång

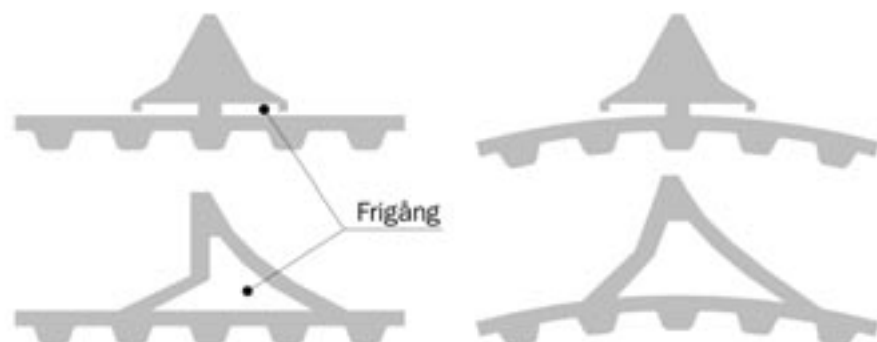

Kuggremmens flexibilitet påverkas inte om medbringarna tillverkas med frigång. Kontakta oss för hjälp med utformningen.

**Medbringarpar**

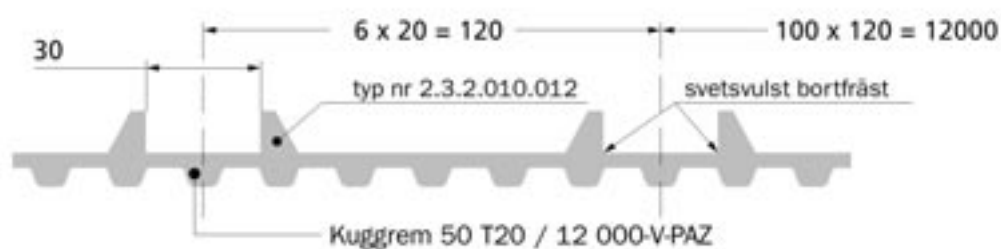

Parvis svetsade medbringare används företrädesvis i transportörer där lägespositionering av detaljer önskas. Standardtolerans på mått mellan medbringarna är  $\pm 0,5$  mm. Med en svetsfixtur kan snävare toleranser på  $\pm 0,2$  mm uppnås. Del i kostnad för fixtur kan tillkomma.

**Medbringare med hål**



Hål kan borrar i standardmedbringare enligt önskemål. Hålen borrar innan medbringarna svetsas fast på kuggremmen. Standardtoleranser, se bilden ovan.

**Medbringare med ingjutna detaljer**

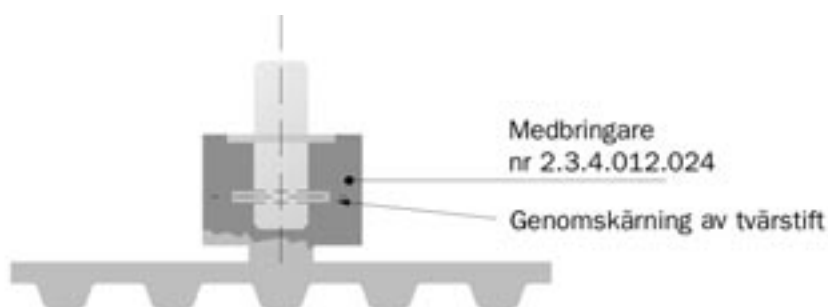

Vi kan leverera medbringare med ingjutna detaljer av exempelvis stål eller aluminium, t.ex. in- eller utvändiga gängor. På dessa kan sedan önskad medbringare skruvas fast. Vi har ett standardsortiment av ingjutningsdetaljer, men kan även gjuta in detaljer erhållna från kund. I sistnämnda fallet behöver vi ca 5% fler detaljer än totala behovet för att kunna göra en nollserie.

**Påsvetsningsteknik**

Medbringarna svetsas fast med hela anliggningsytan mot ryggen på kuggremmen genom smältning.

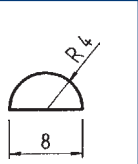
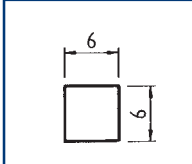
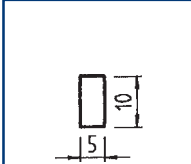
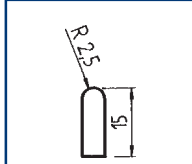
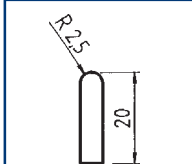
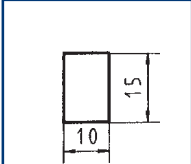
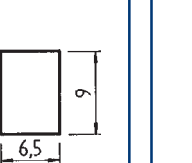
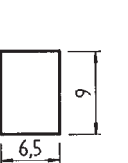
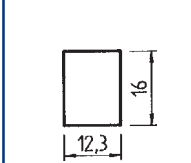
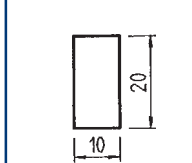
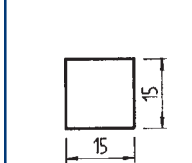
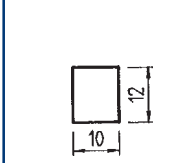
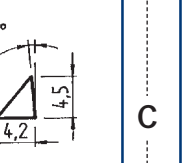
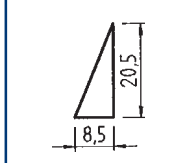
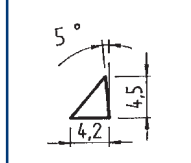
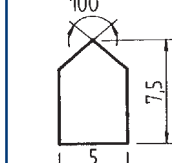
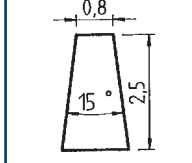
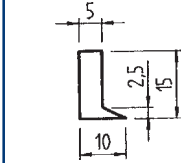
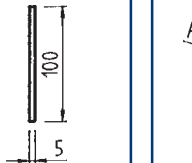
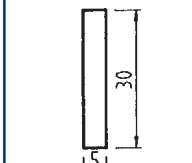
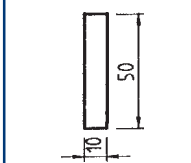
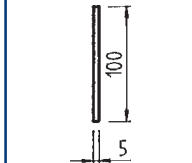
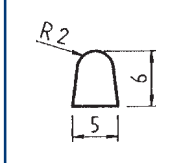
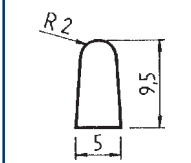
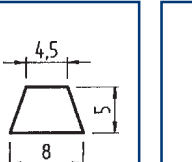
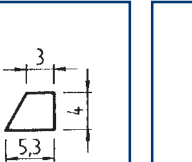
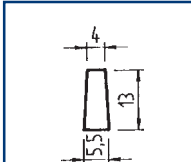
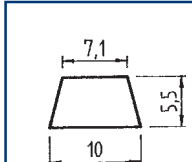
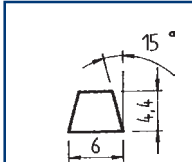
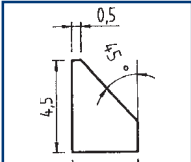
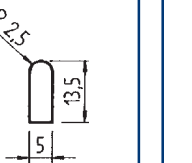
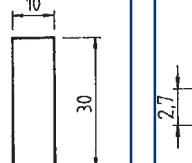
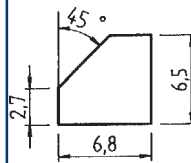
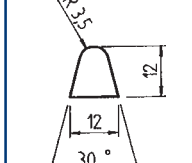
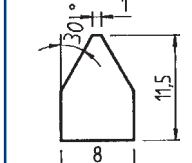
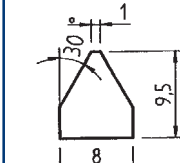
 <p>L = 100 231.008.004</p>	 <p>L = 140 232.006.006</p>	 <p>L = 60 232.010.005</p>	<p><b>A</b></p>  <p>L = 195 232.015.005</p>	 <p>L = 100 232.020.005</p>	 <p>L = 26 232.015.010</p>
 <p>L = 100 232.018.010</p>	 <p>L = 100 232.009.006</p>	 <p>L = 105 232.016.012</p>	<p><b>B</b></p>  <p>L = 100 232.010.020</p>	 <p>L = 110 232.015.015</p>	 <p>L = Extruderad 232.012.010</p>
 <p>L = 130 232.010.012</p>	 <p>L = 100 232.008.020</p>	 <p>L = 101.6 232.004.004</p>	<p><b>C</b></p>  <p>L = 100 232.005.007</p>	 <p>L = 64 232.001.002</p>	 <p>L = 47.5 232.010.015</p>
<p><b>1</b></p>	<p><b>2</b></p>	<p><b>3</b></p>	<p><b>4</b></p>	<p><b>5</b></p>	<p><b>6</b></p>
 <p>L = 105 232.032.003</p>	 <p>L = 100 232.030.005</p>	 <p>L = 100 232.050.010</p>	<p><b>D</b></p>  <p>L = 100 232.100.005</p>	 <p>L = Extruderad 233.006.005</p>	 <p>L = Extruderad 233.009.005</p>
 <p>L = 100 233.005.008</p>	 <p>L = 25 233.004.005</p>	 <p>L = 100 233.013.006</p>	<p><b>E</b></p>  <p>L = 100 233.005.010</p>	 <p>L = 101.6 233.004.007</p>	 <p>L = 101.6 233.004.004</p>
 <p>L = 38 234.005.013</p>	 <p>L = 135 234.010.030</p>	 <p>L = 64 234.006.006</p>	<p><b>F</b></p>  <p>L = 110 234.012.012</p>	 <p>L = 100 234.008.011</p>	 <p>L = 100 234.008.009</p>

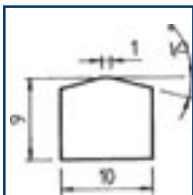
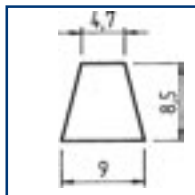
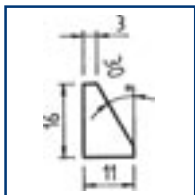
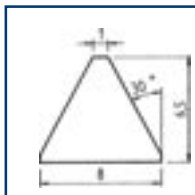
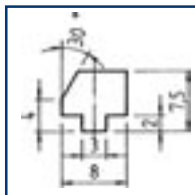
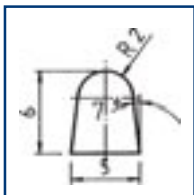
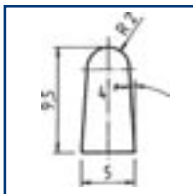
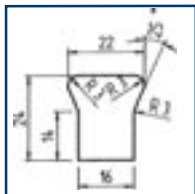
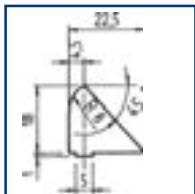
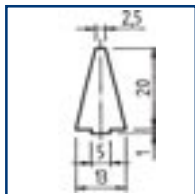
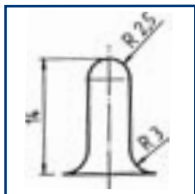
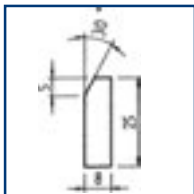
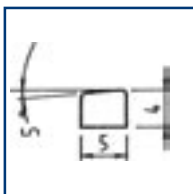
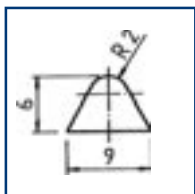
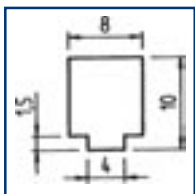
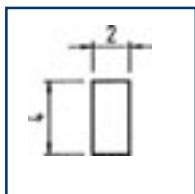
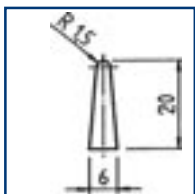
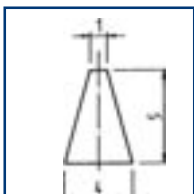
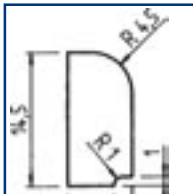
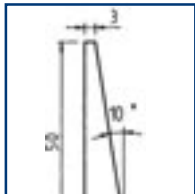
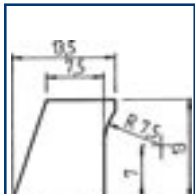
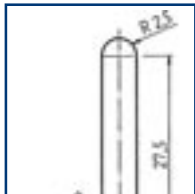
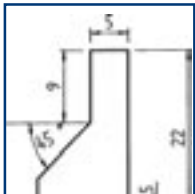
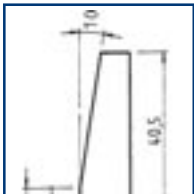
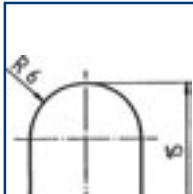
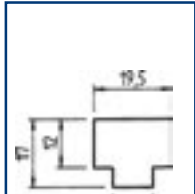
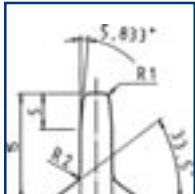
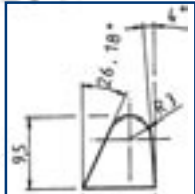
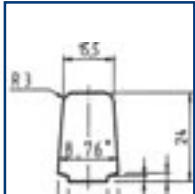
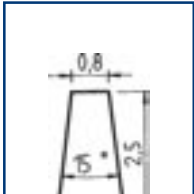
 <p>L = 110 234.010.011</p>	 <p>L = 100 234.009.006</p>	 <p>L = 50 234.011.016</p>	<p><b>A</b></p>  <p>L = 100 235.001</p>	 <p>L = 100 235.026</p>	 <p>L = 100 235.028</p>
 <p>L = 100 235.029</p>	 <p>L = 150 235.033</p>	 <p>L = 101.6 235.038</p>	 <p>L = 100 235.040</p>	 <p>L = 76.2 235.063</p>	 <p>L = 100 235.117</p>
 <p>L = 65 235.277</p>	 <p>L = 100 235.293</p>	 <p>L = 100 235.294</p>	 <p>L = 100 235.358</p>	 <p>L = 101.6 235.400</p>	 <p>L = 100 235.347</p>
<p><b>1</b></p>	<p><b>2</b></p>	<p><b>3</b></p>	<p><b>4</b></p>	<p><b>5</b></p>	<p><b>6</b></p>
 <p>L = 100 235.119</p>	 <p>L = 35 235.137</p>	 <p>L = 32 235.106</p>	 <p>L = 100 235.054</p>	 <p>L = 290 235.016</p>	 <p>L = 80 236.148</p>
 <p>L = 150 235.356</p>	 <p>L = 100 236.114</p>	 <p>L = 100 235.927</p>	 <p>L = 100 236.129</p>	 <p>L = 25 236.134</p>	 <p>L = 64 232.001.002</p>
<p><b>E</b></p>					

Medbringarna på dessa sidor är endast ett urval ur de mer än 2300 standardmedbringarna i vårt sortiment.



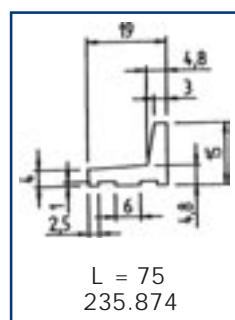
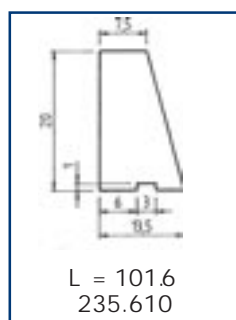
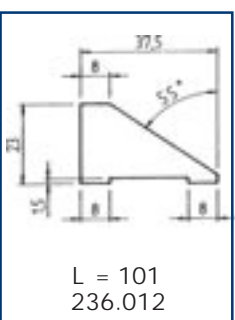
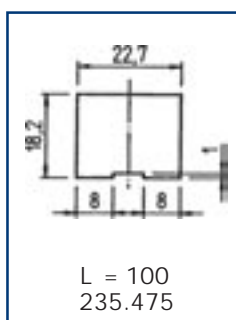
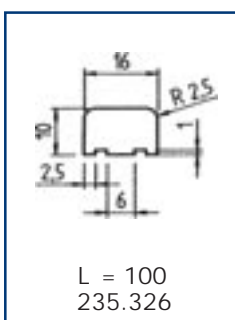
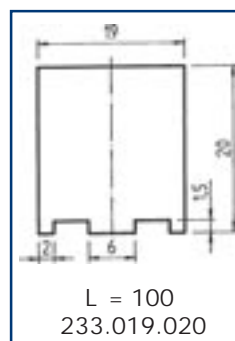
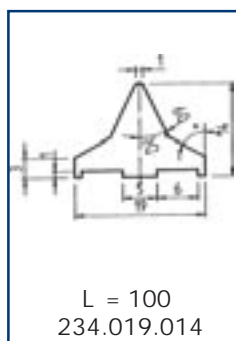
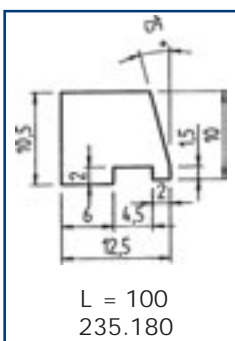
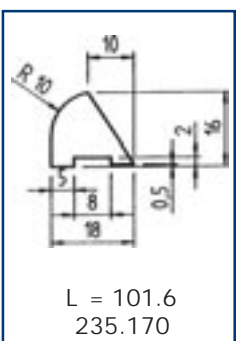
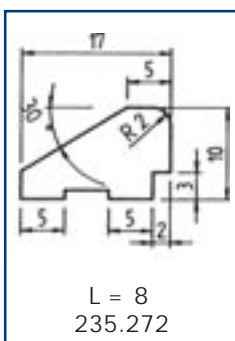
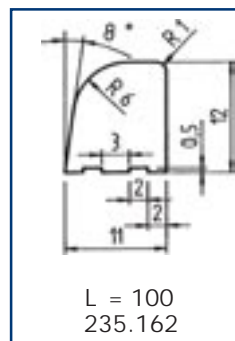
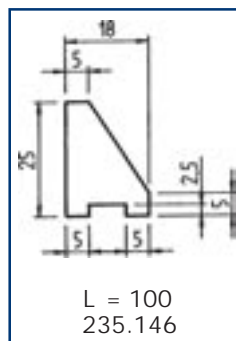
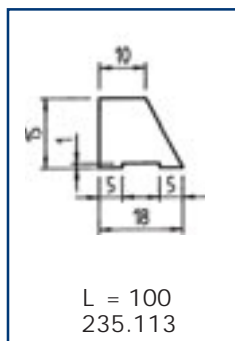
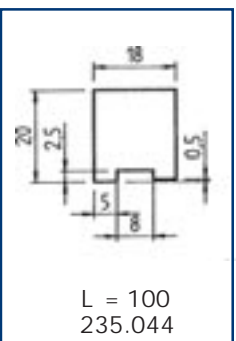
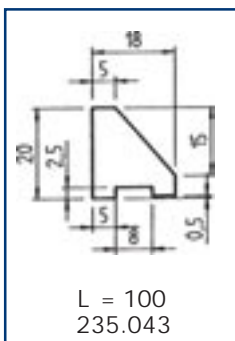
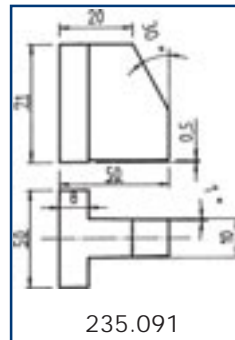
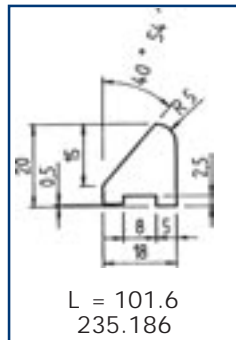
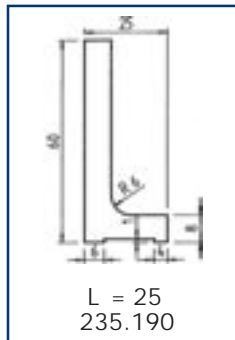
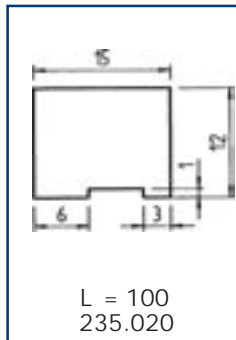
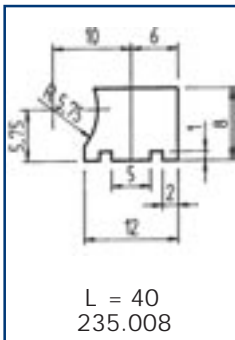
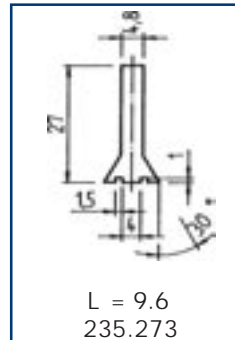
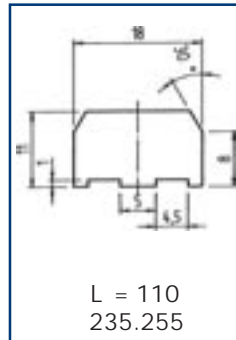
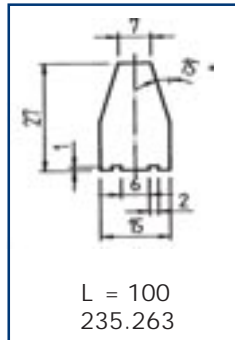
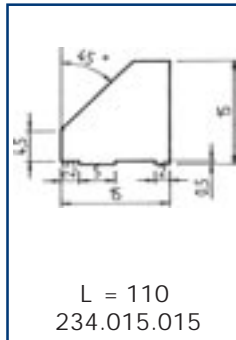
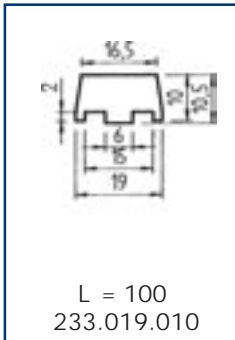

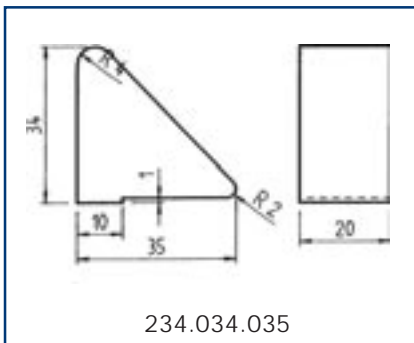

234.034.035

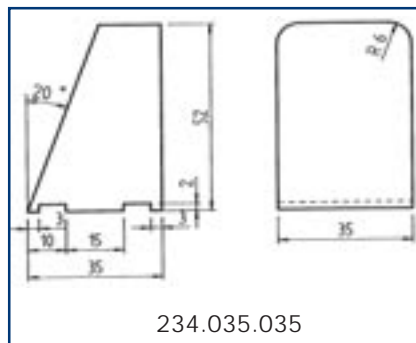

234.035.035

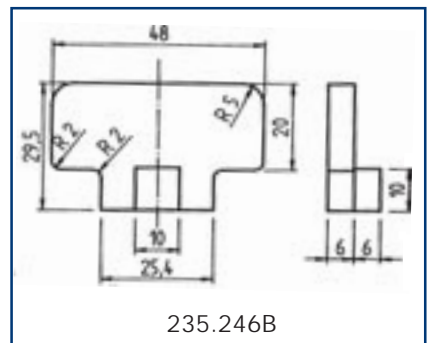

235.246B

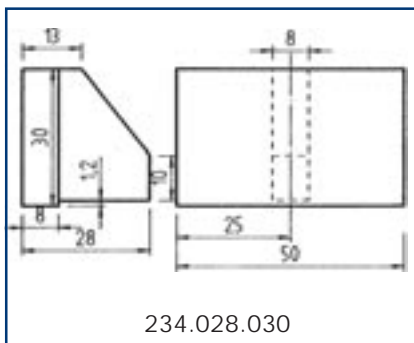

234.028.030

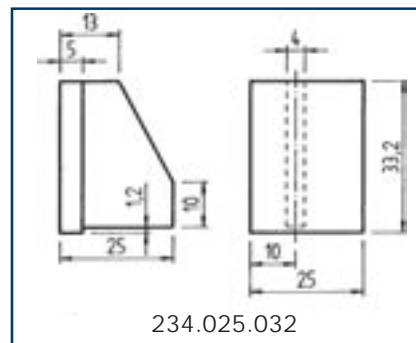

234.025.032

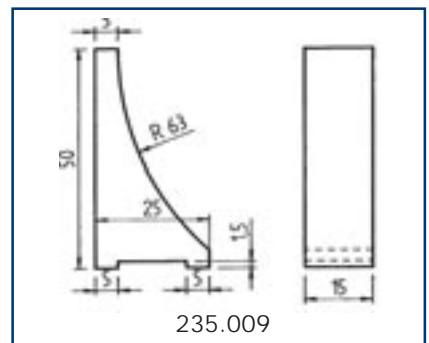

235.009

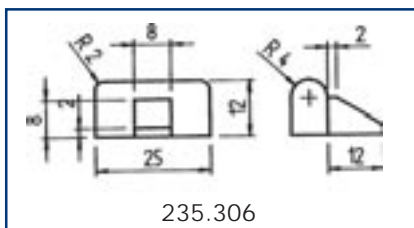

235.306

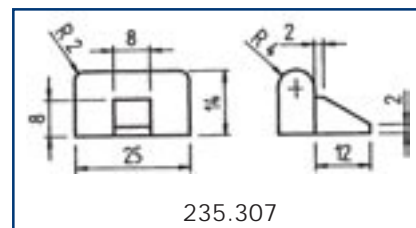

235.307

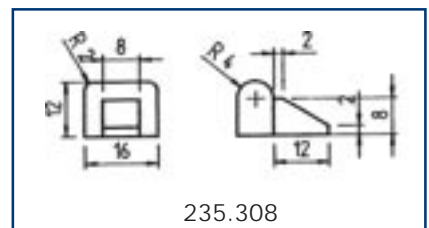

235.308

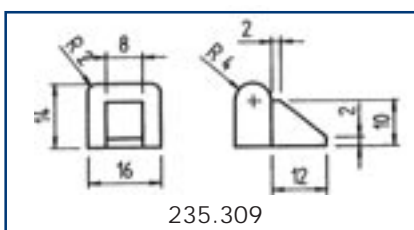

235.309

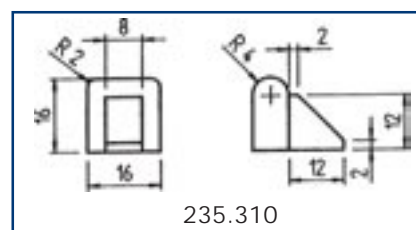

235.310

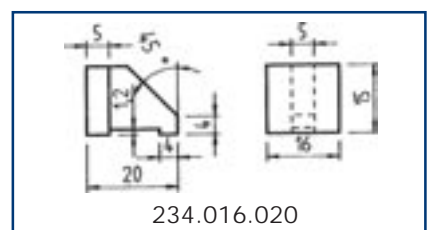

234.016.020

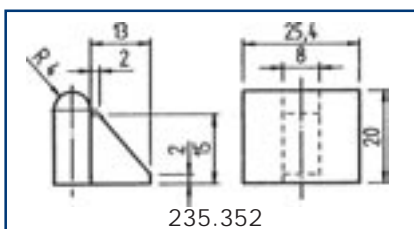

235.352

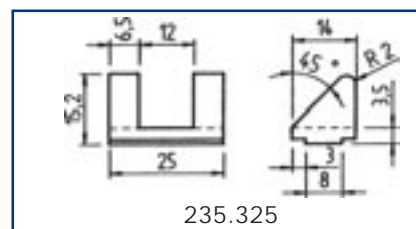

235.325

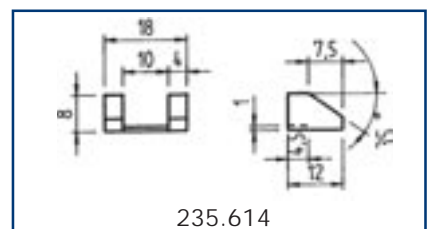

235.614

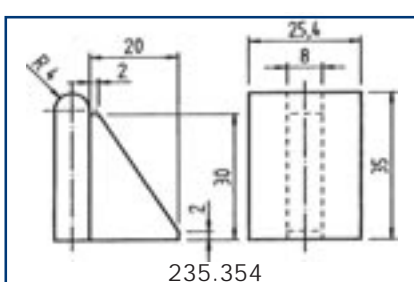

235.354

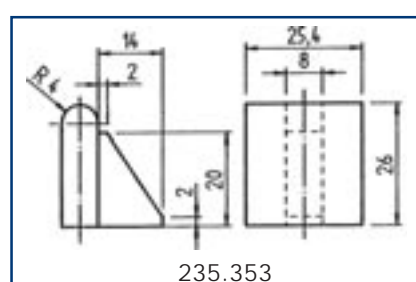

235.353

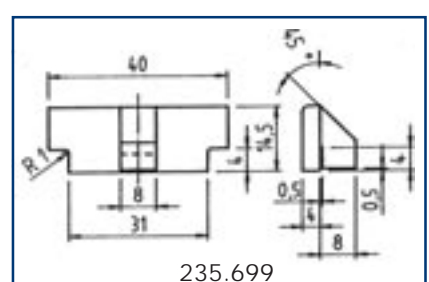

235.699

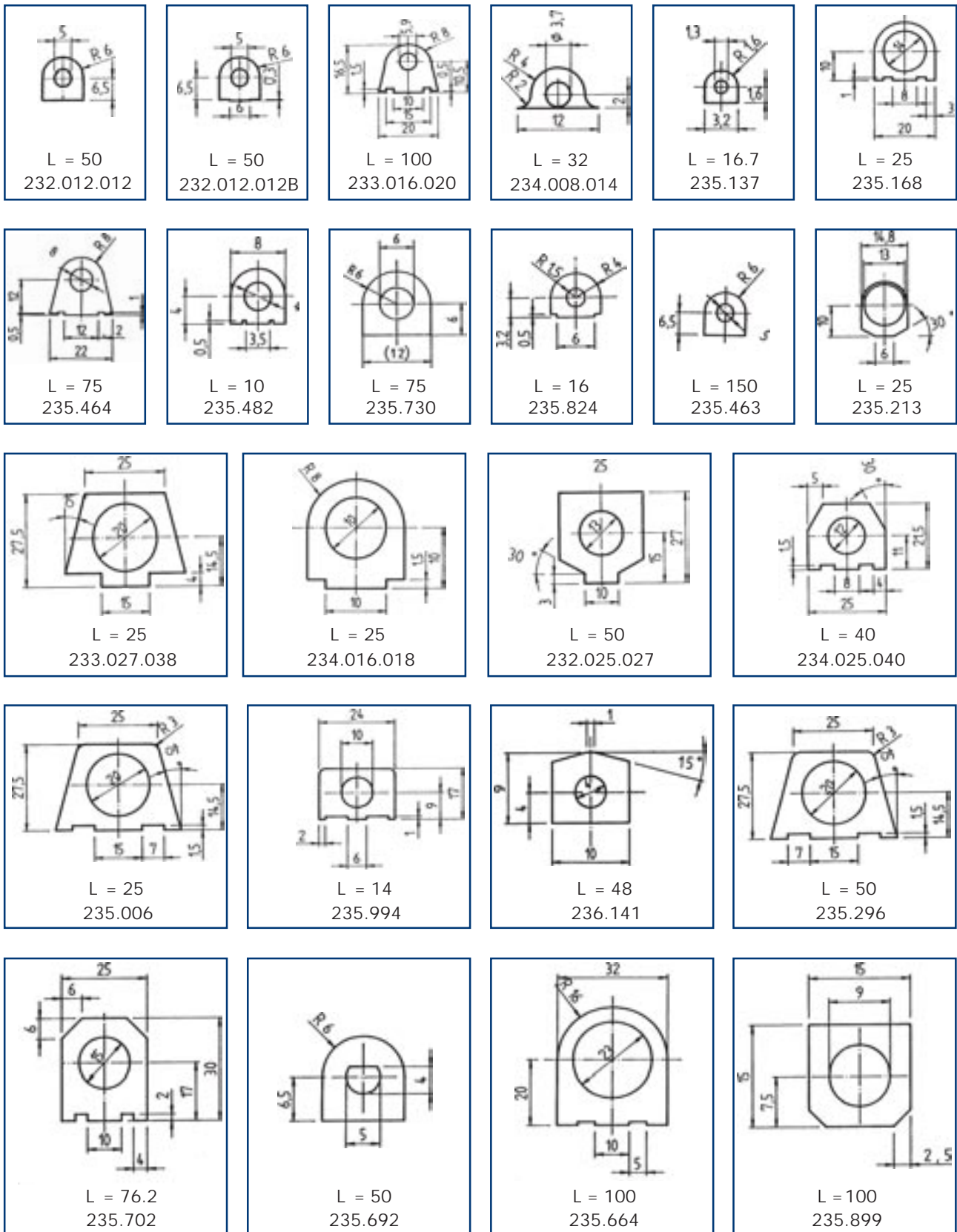

Medbringarna på dessa sidor är endast ett urval ur de mer än 2300 standardmedbringarna i vårt sortiment.

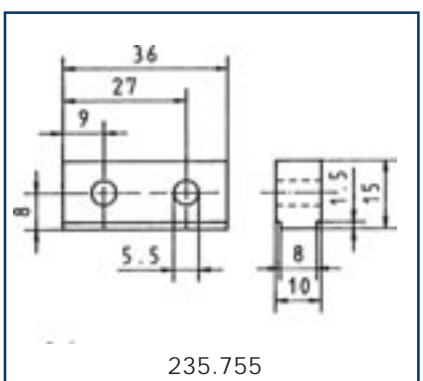
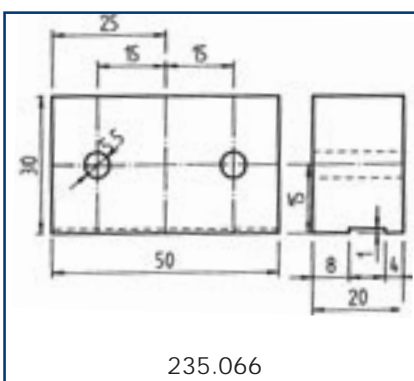
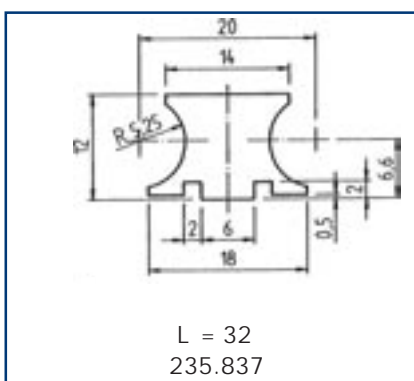
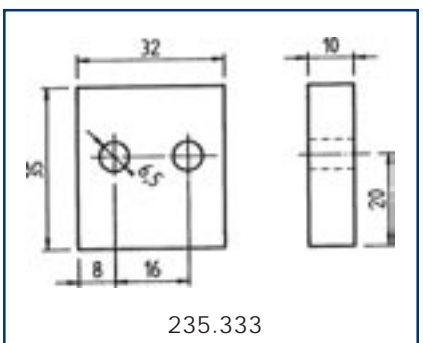
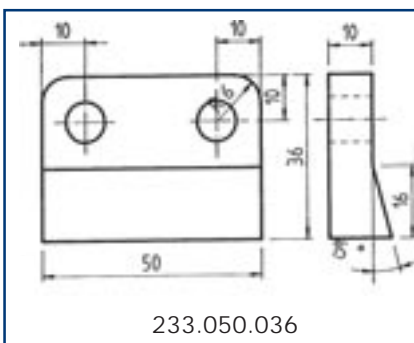
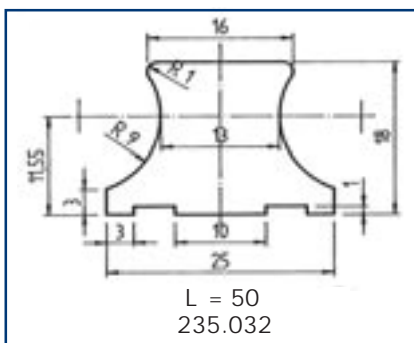
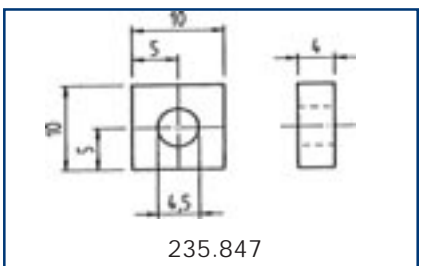
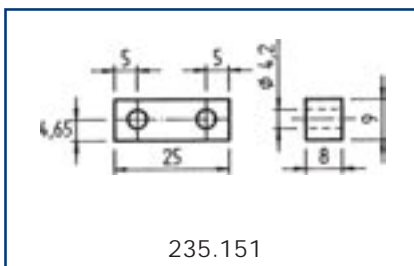
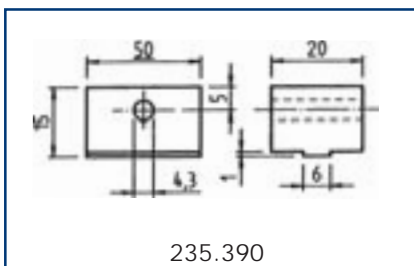
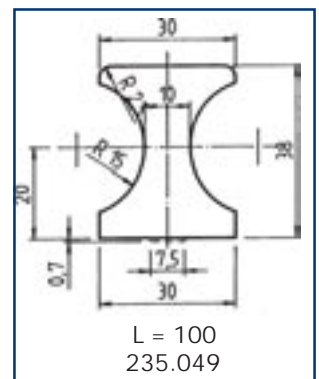
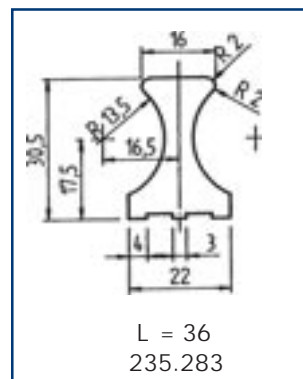
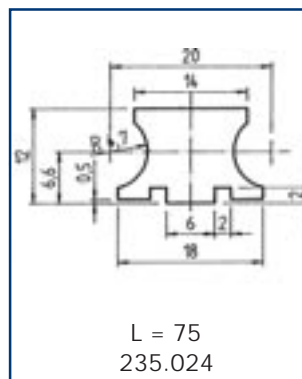
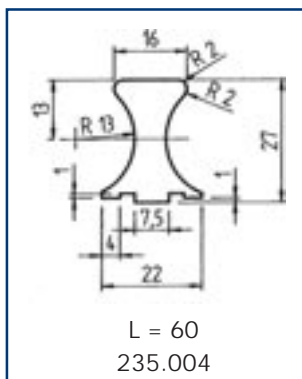
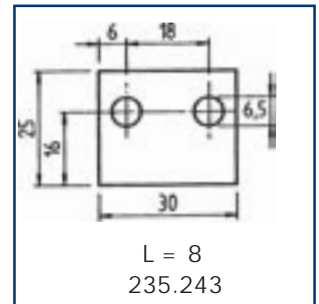
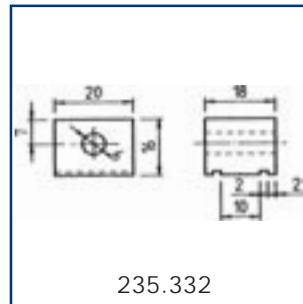
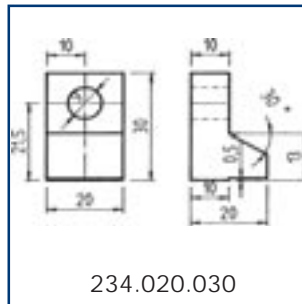
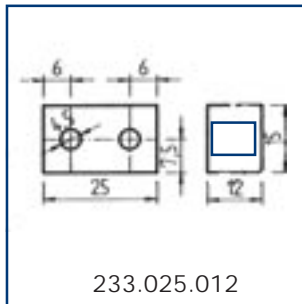

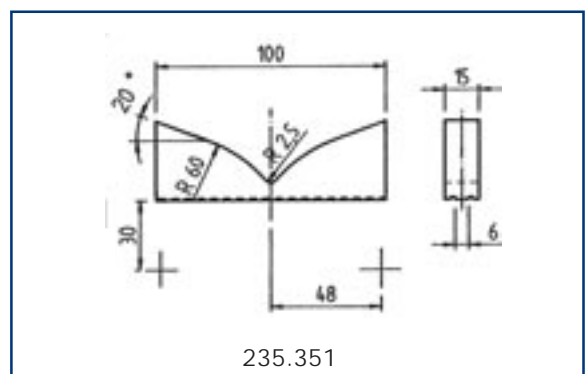
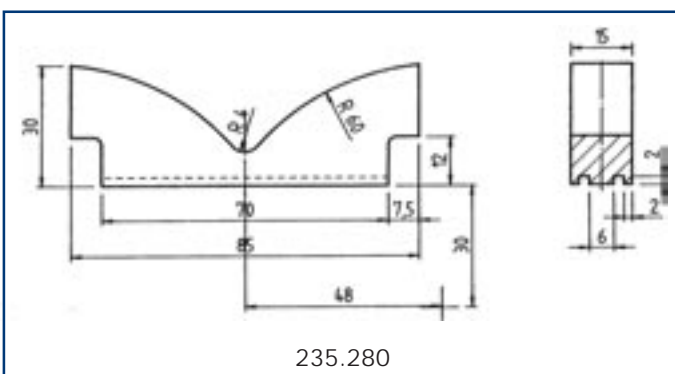
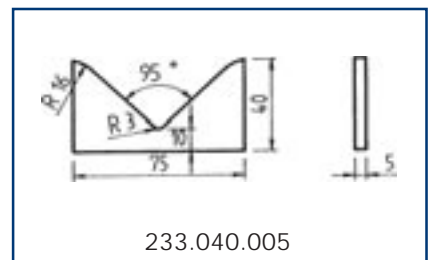
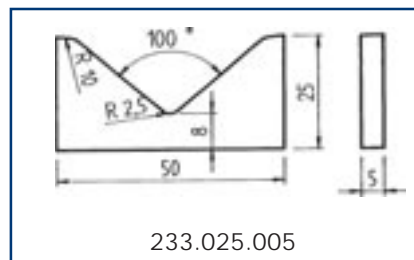
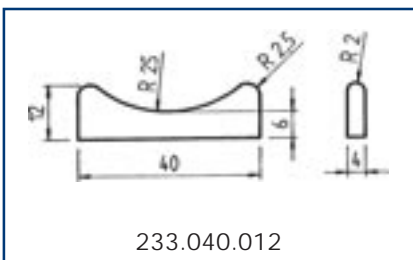
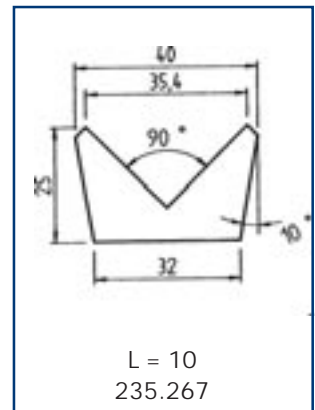
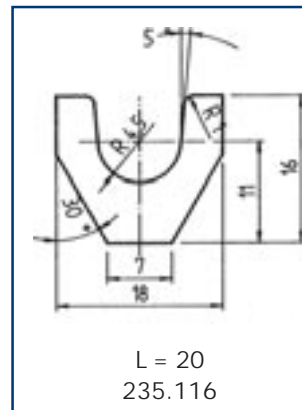
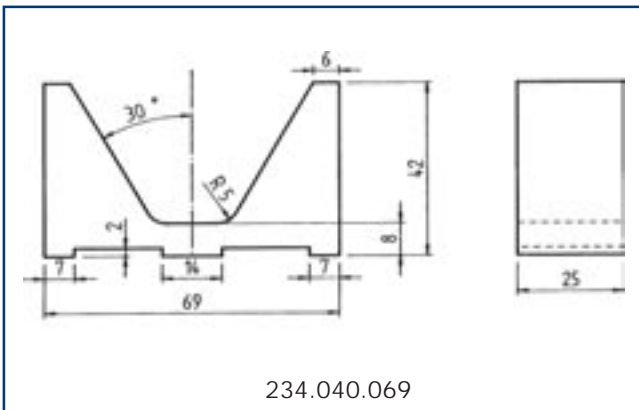
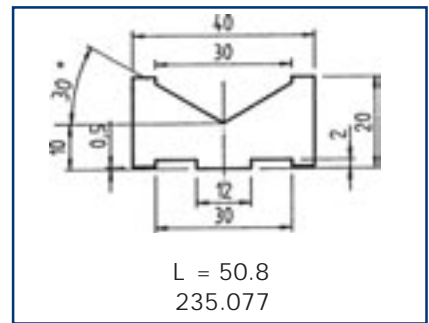
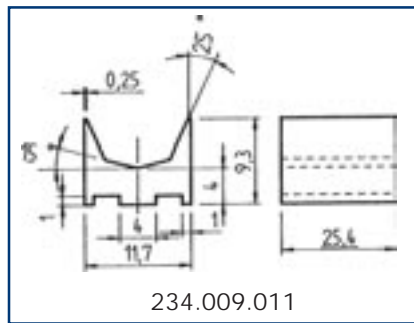
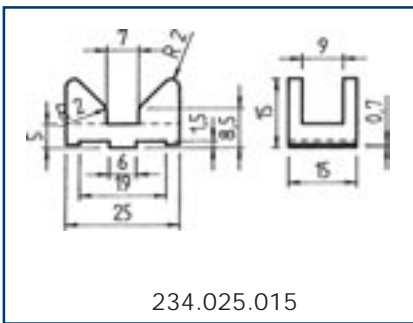
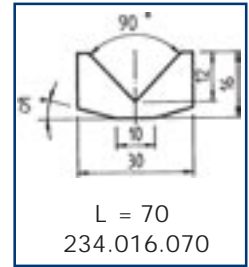
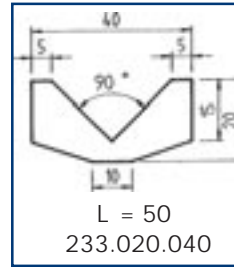
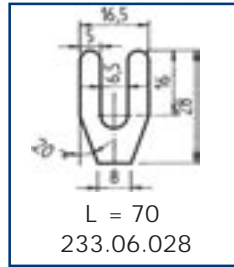
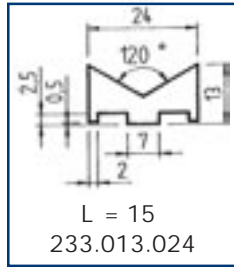
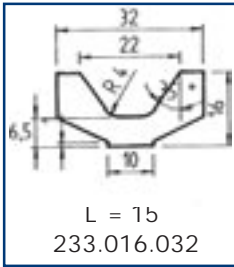

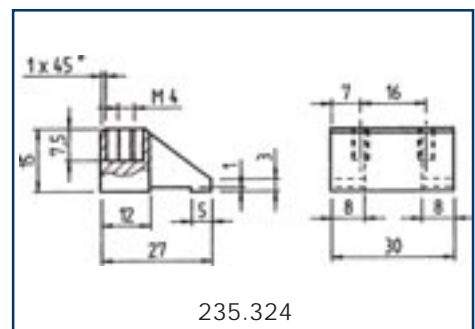
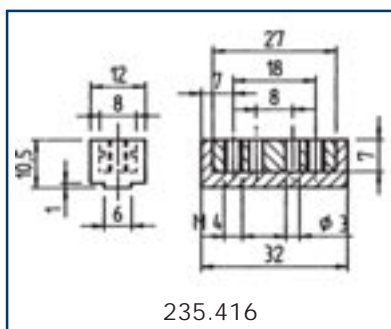
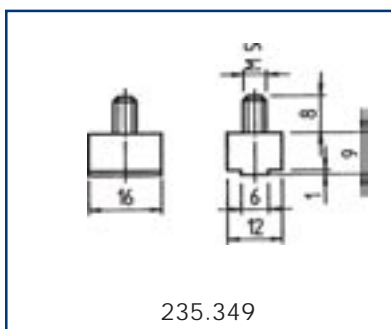
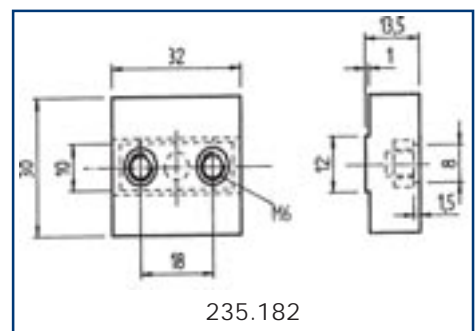
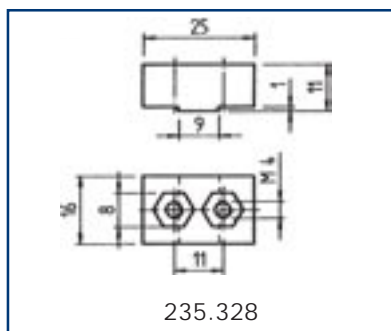
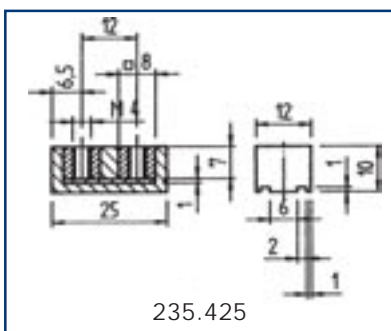
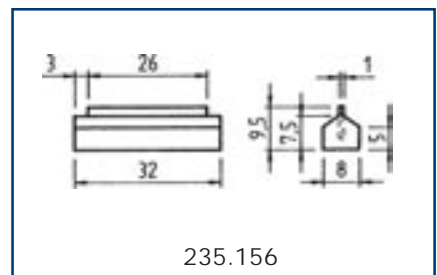
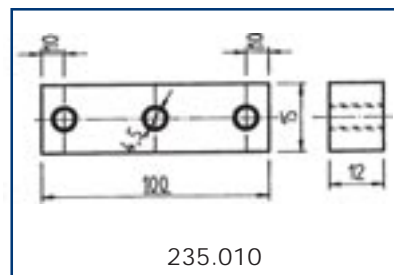
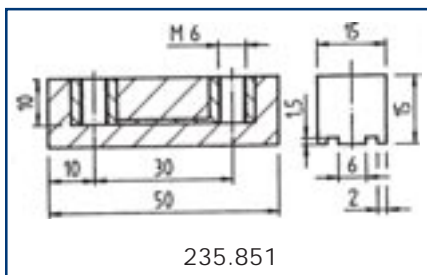
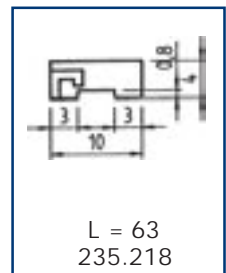
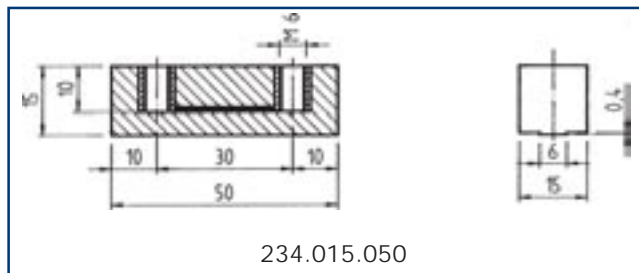
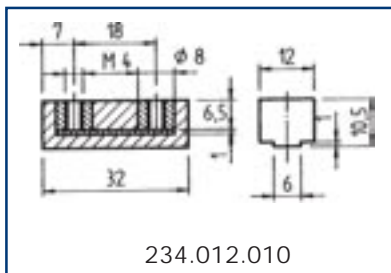
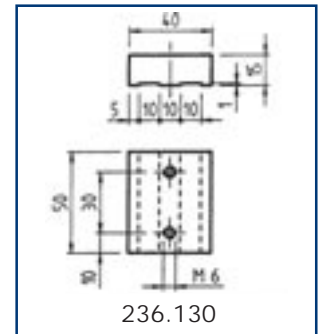
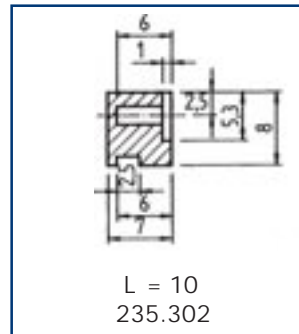
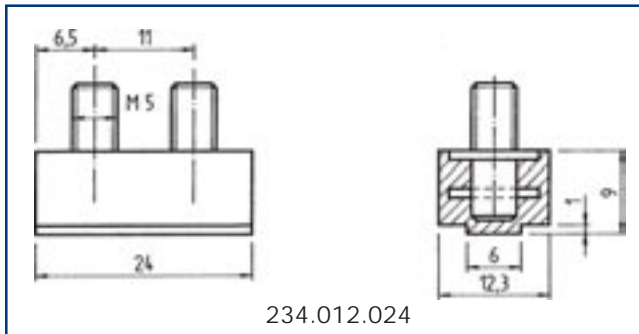

Medbringarna på dessa sidor är endast ett urval ur de mer än 2300 standardmedbringarna i vårt sortiment.